

ATLANTA

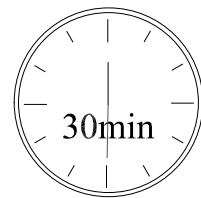

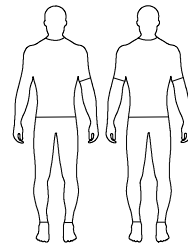

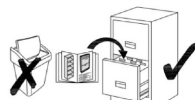
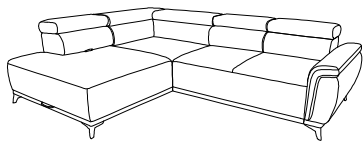
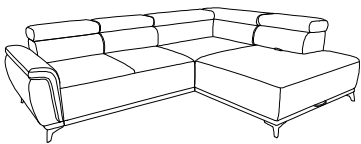
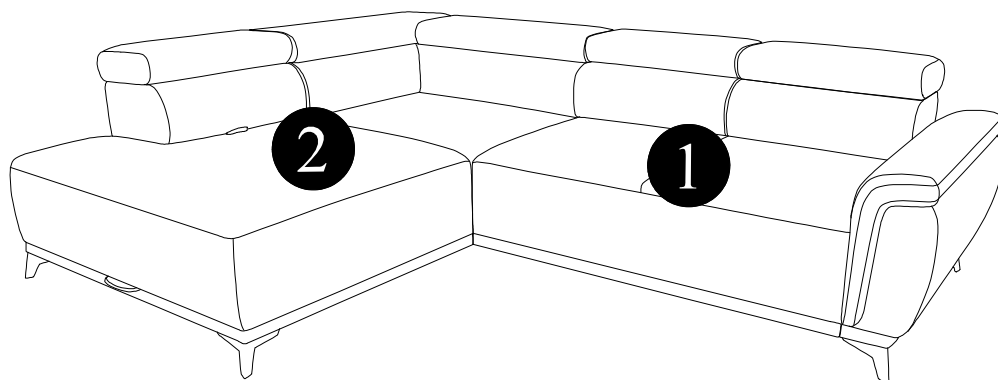

Teil	L	W	H	Pcs	Colli
1	69	100	165	1x	1/3
2	69	116	203	1x	2/3



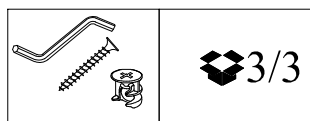
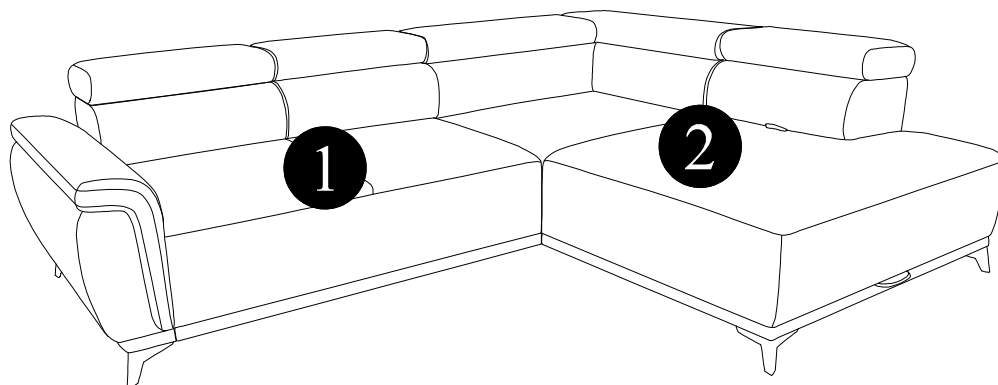

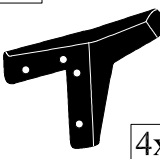
L

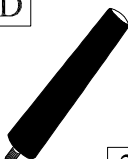

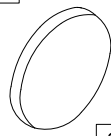
R

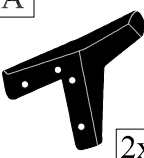
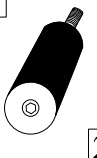

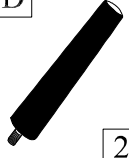
A  4x	B  4x	C  2x	D  2x	E  16x	F  16x	G  2x
H-120	H-120	H-50	H-120	5x30	M6	

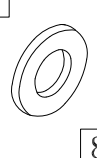
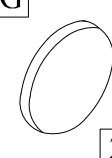
A 	B 	C 	D 	E 	F 	G 
H-120 2x	H-120 2x	H-50 2x	H-120 2x	5x30 8x	M6 8x	M6 2x

R

1

L

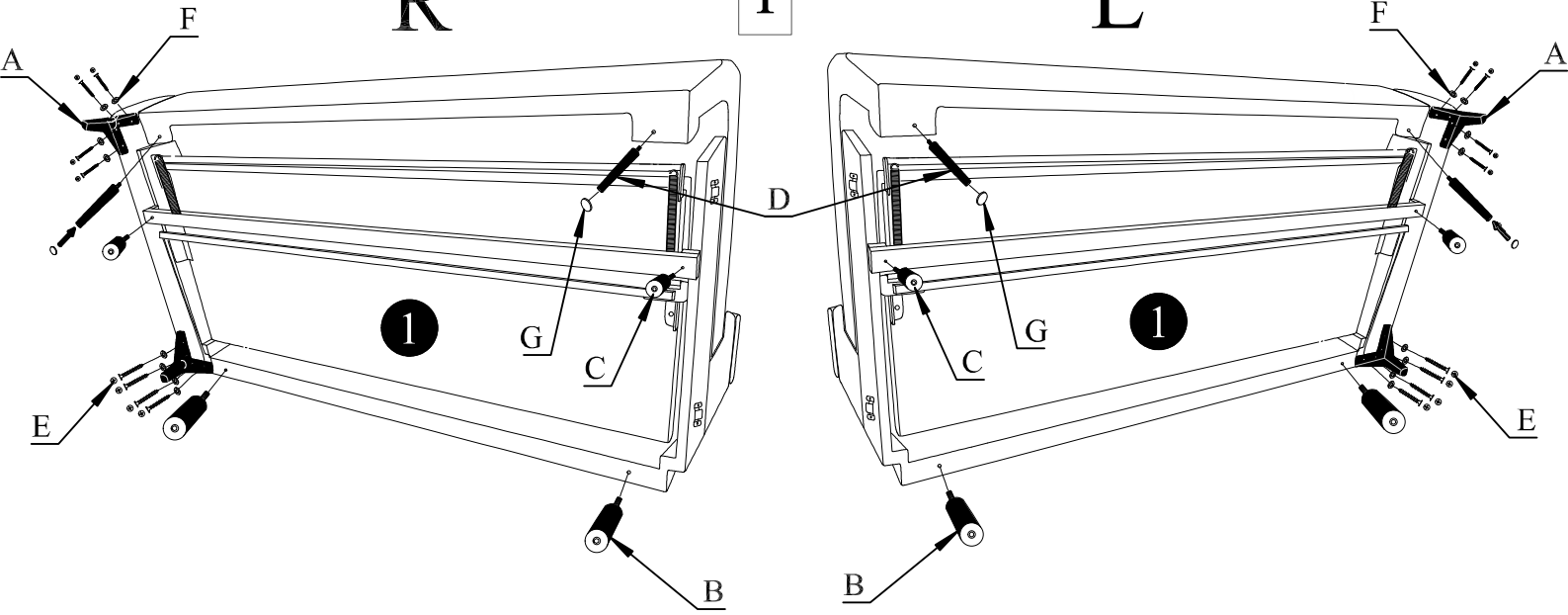

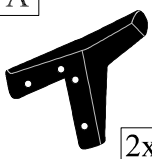
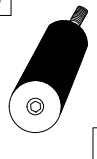
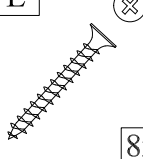
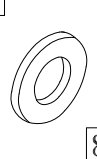
A 	B 	E 	F 
H-120 2x	H-120 2x	5x30 8x	M6 8x

2

R

L

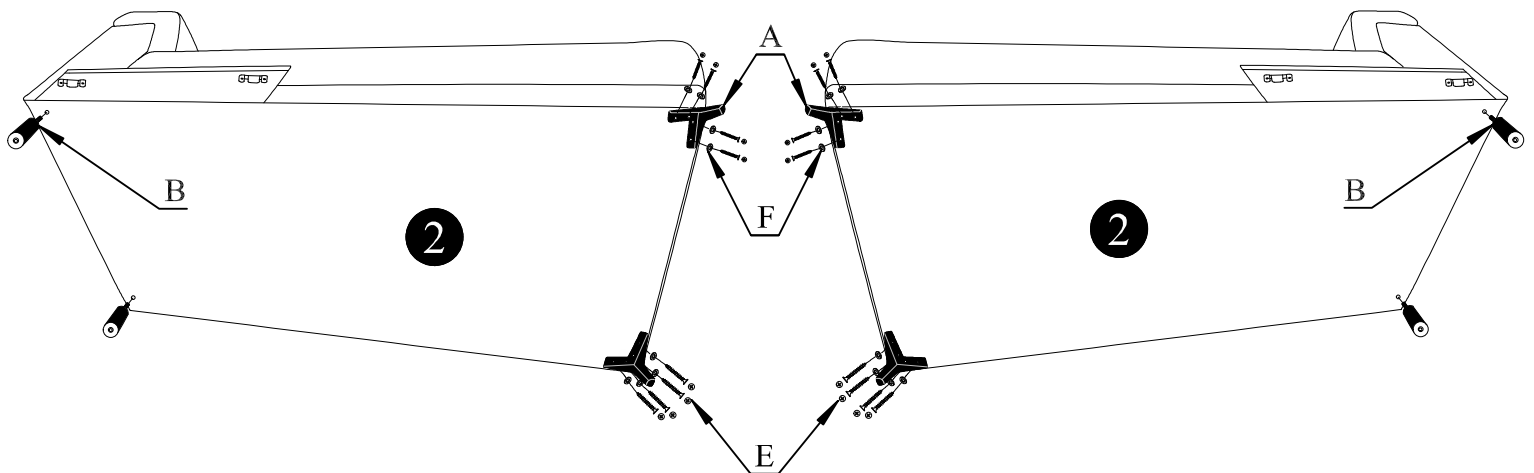

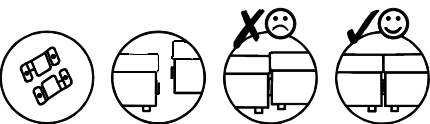

3

R

